













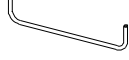



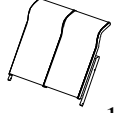

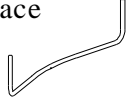
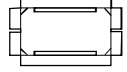

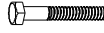
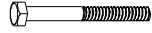
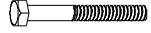
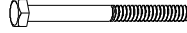
# ASSEMBLY INSTRUCTION

## NOTE:

- 1.Keep children away during assembly. This item contains small parts which can be swallowed by children.
- 2.Retain the assembly instruction for future reference.

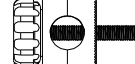
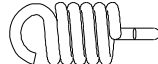
## PART LIST

Leg side base  A 2PCS	Front leg  B 2PCS	Back leg  C 2PCS	Top cross beam  D 1PC	"U" support bar  E 1PC	Swing armrest (left)  Fa 1PC	Swing armrest (right)  Fb 1PC	Seat frame  G 1PC	Back frame  H 1PC
Canopy brace  I 2PCS	Canopy "U" brace  J 2PCS	Canopy cover  K 1PC	Bolt (M6*40)  a 2PCS	Bolt (M6*45)  b 2PCS	Bolt (M6*70)  c 4PCS	Bolt (M8*50)  d 2PCS	Bolt (M8*95)  e 4PCS	Metal washer (M6)  f 16PCS
Metal washer (M8)  g 10PCS	PE washer (3mm)  h 2PCS	PE washer (6mm)  i 4PCS	Nut (M6)  j 8PCS	Nut (M8)  k 4PCS	Knob  l 2PCS	Spring hook  m 2PCS	Hex wrench  n 2PCS	Touch-up paint bottle  o 1PC

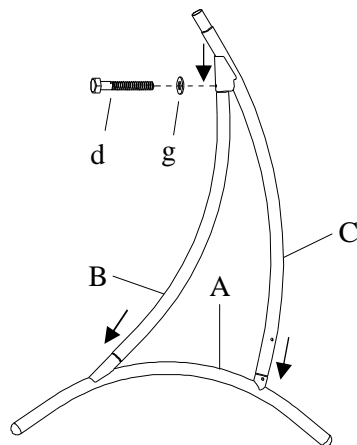

Fig. 1

**Step 1:** Install the front leg (B) on leg side base (A), then install the back leg (C) using M8\*50 bolt (d) and M8 washer (g) as shown in **Fig.1**. Repeat this procedure for the other side.

**Step 2:** Install top cross beam (D) to both end of the back leg (C) as shown in **Fig. 2**. Attach "U" support bar (E) to leg assembly on both sides using M8\*95 bolts (e) and M8 washers (g) and M8 nuts (k) as shown in **Fig.2**

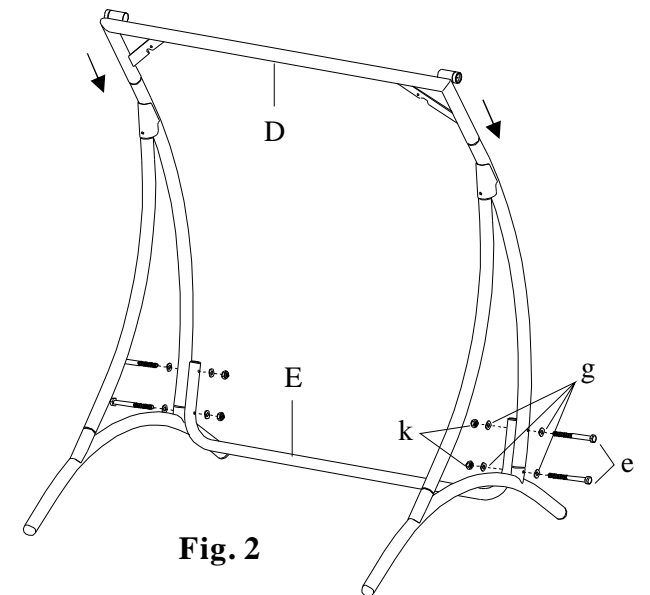
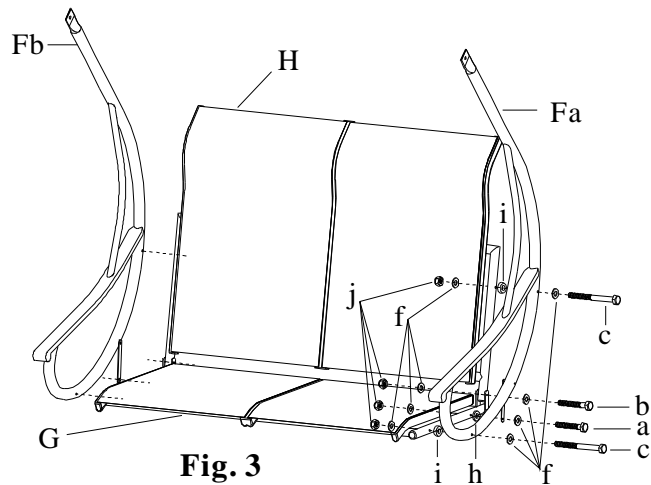
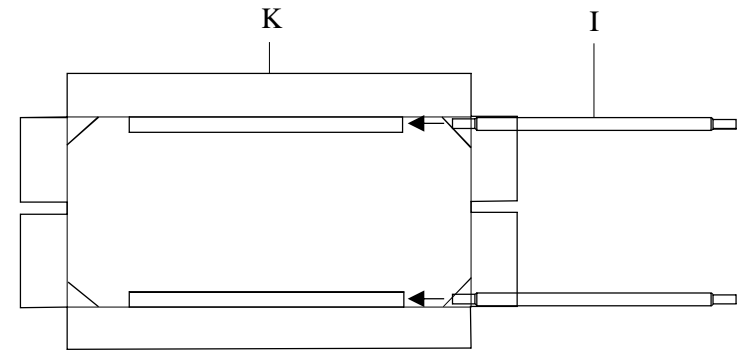

Fig. 2



**Fig. 3**

**Step 3:** Attach swing armrest (Fa and Fb) to seat frame (G) using M6\*70 bolt (c) and 6mm PE washer (i) [M6\*40 bolt (a) and 3mm PE washer (h)] and M6 washers (f) and nuts (j) as shown in **Fig. 3**. Then install back frame (H) using M6\*70 bolt (c) and 6mm PE washer (i) [M6\*45 bolt (b)] and M6 washers (f) and nuts (j) as shown in **Fig. 3**.



**Fig. 4**

**Step 4:** Insert canopy brace (I) into the canopy cover (K) on both sides as shown in **Fig. 4**.

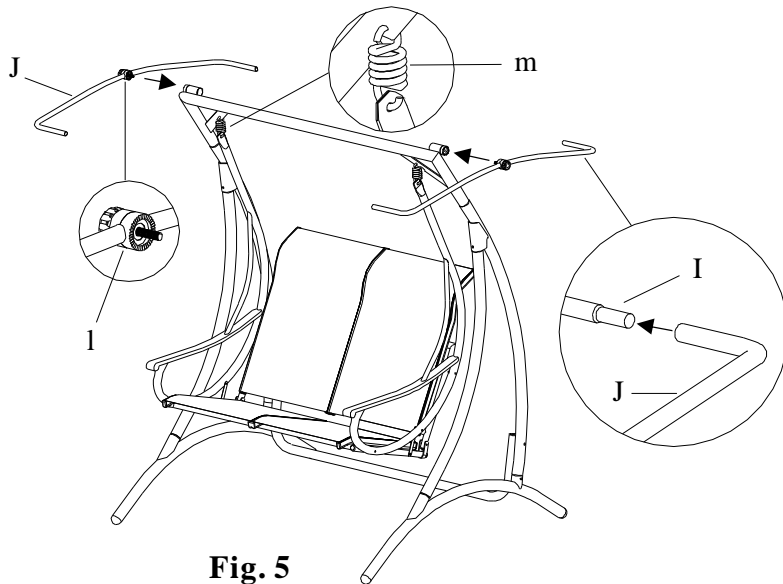

**Fig. 5**

**Step 5:** Install the spring hook (m) into hole on top cross beam (D), make sure the spring hook (m) is fully hooked as shown in **Fig. 5**. Then hook the swing armrest (Fa and Fb). Install the knob (l) to the canopy "U" brace (J), connect the canopy "U" brace (J) to canopy braces (I) on both sides until the teeth on the gears mesh.

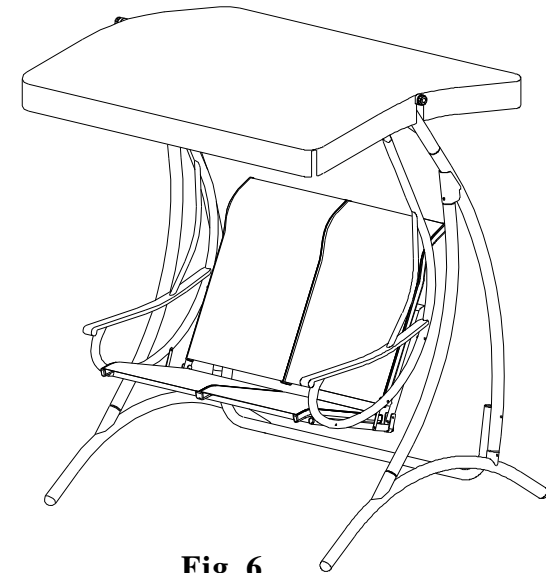

**Fig. 6**

**Step 6:** Verify and tighten again all bolts and nuts to assure stability and security. Then the swing chair is now ready for use as shown in **Fig. 6**.